

Sink Canova 32" x 20" – U/M



Kitchen Sinks

Code: 1337 660

AISI 304 Stainless steel

Satin finish

Undermount

x cross bending for easy water draining



DETAILS

Series Canova

Material AISI 304 stainless steel

Finish Satin finish

Thickness 16 Gauge (1.5 mm)

Inset type Undermount

Overall dimensions 31 1/2" x 19 1/2"

Bowl dimension 1 bowl 30" x 17"

Bowls depth 10"

Cut out 30" x 18"

Waste fitting type 3 1/2" - with stainless steel basket

Bowls bottom X cross bending for easy water draining

Underside Protected with heavy duty undercoating

Fixing system Undermount fixing kit (brass insert and clips)

FEATURES

Diamond-shape bottom The draining of water is an important feature in a sink, and it's always taken good care of in Foster products. In the bent-welded sinks, which would have a flat bottom, the proper draining is guaranteed by the elegant beveling, which helps the water flow.

Double recess The "rails" system makes it possible use a combination of numerous accessories. Grids, Chopping boards, utensils' ranging systems, bowls and containers of different dimension can be alternates in the workspace with a simple gesture, and can easily be stacked, in order to be on hand at all times.

High thickness 1.5 mm thick steel. A significant thickness, which guarantees the maximum sturdiness and durability.

Basket 3,5" waste fitting The drain is equipped with a large 3.5" drain, with the practical basket cap that prevents the discharge of solid parts.

TECHNICAL DATA

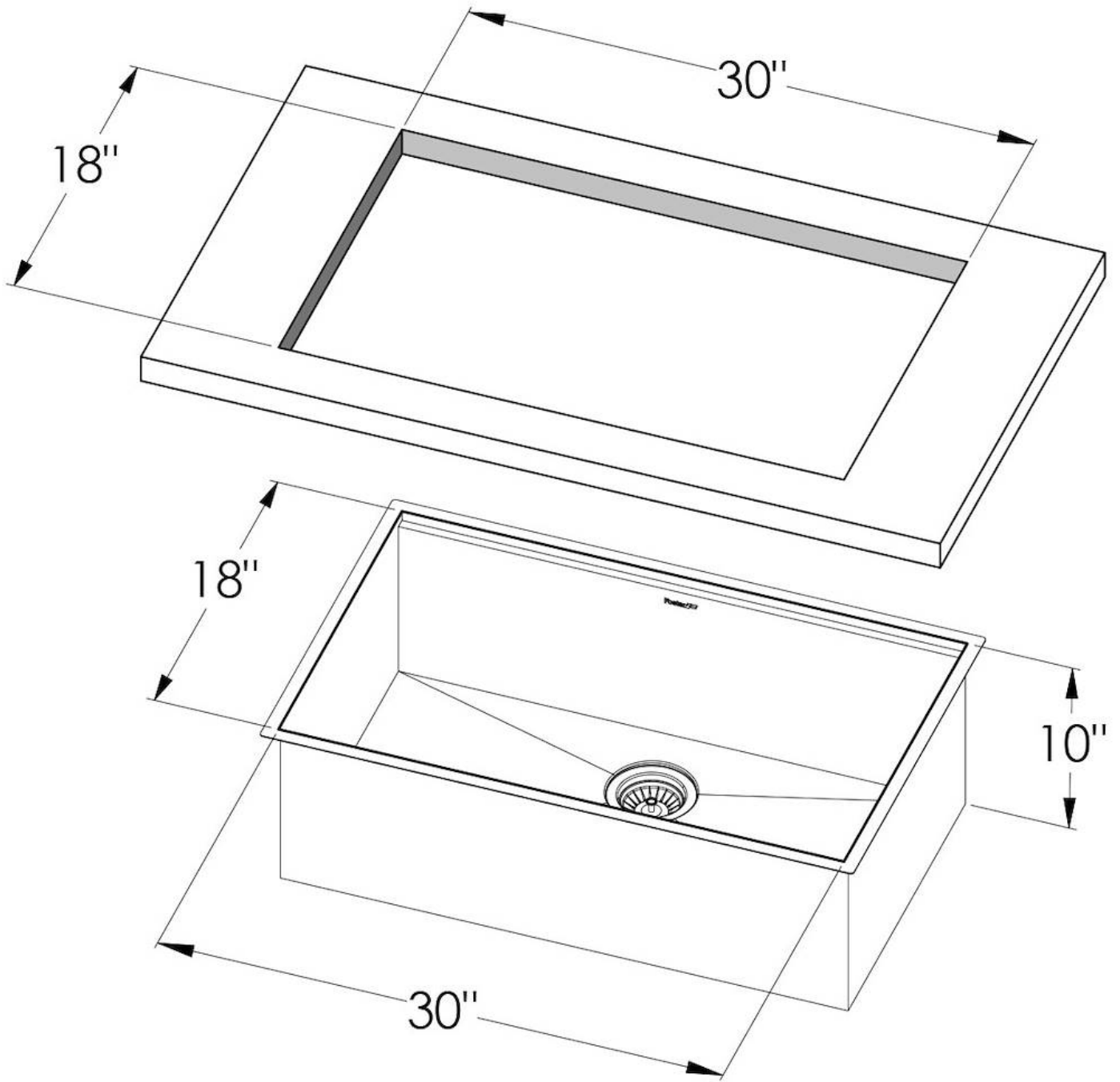

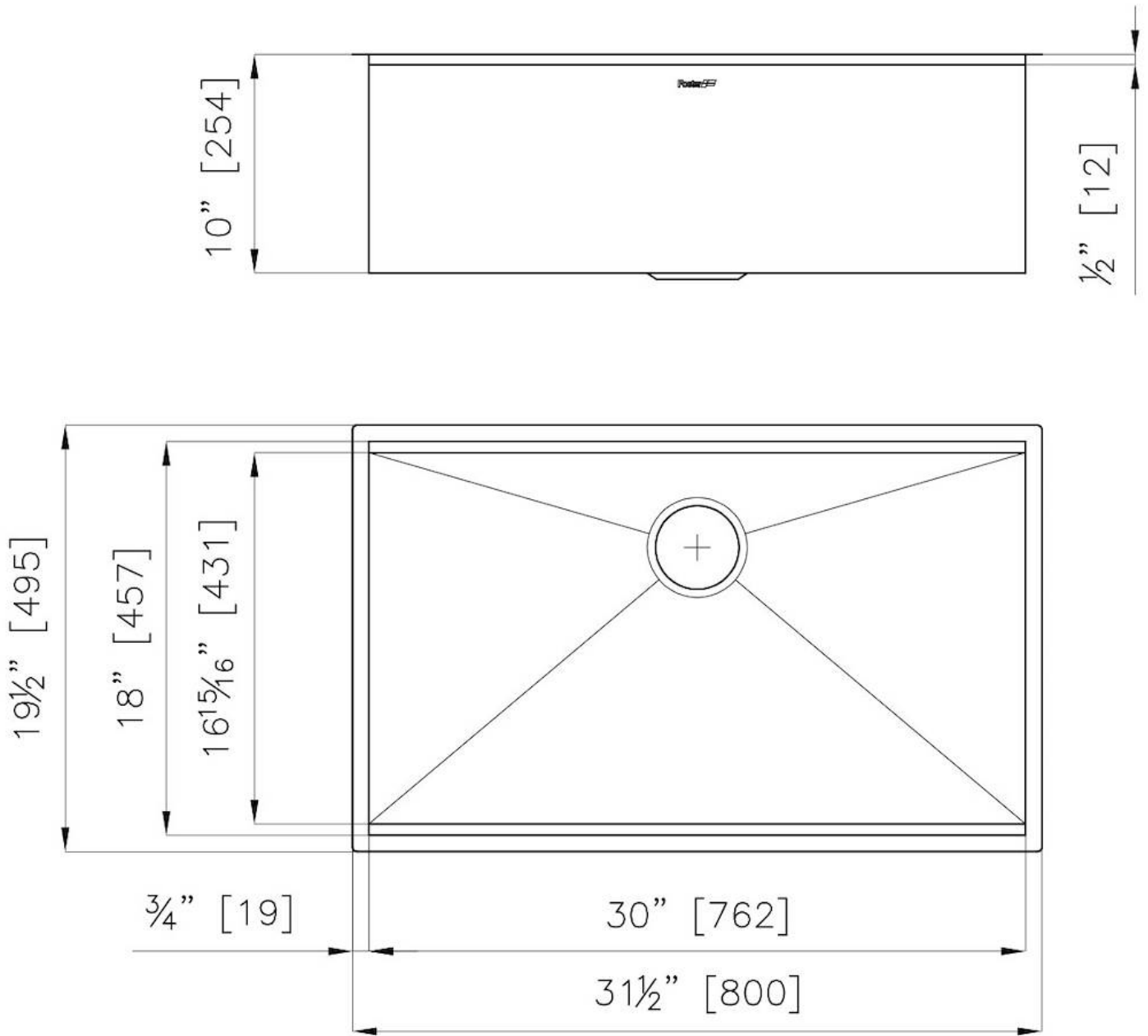

Canova Optional accessories

The "rails" system makes it possible to use a combination of numerous accessories. Grids, chopping boards, utensils' ranging system, bowls and containers of different dimensions can be alternated in the workspace with a simple gesture, and can easily be stacked, in order to be on hand at all times.

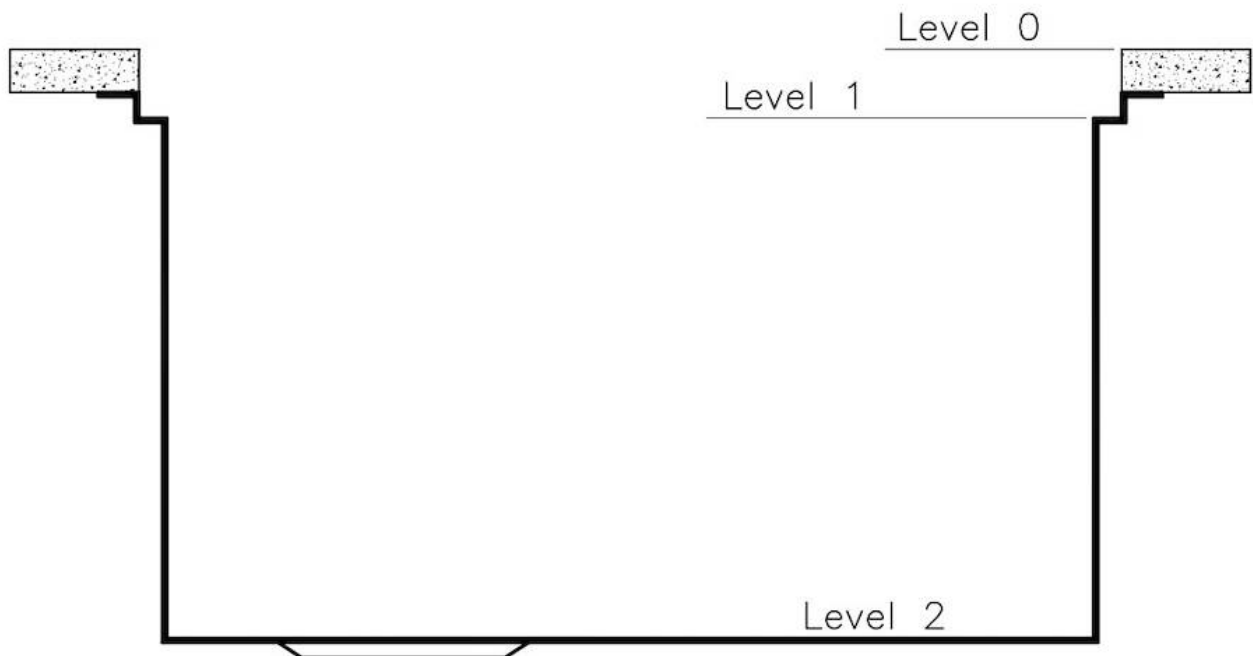

Canova Level 0

Compatible accessories:

8644 102



Canova Level 1

Compatible accessories:

8100 605

8644 104



Canova Level 2

Compatible accessories:

8100 605

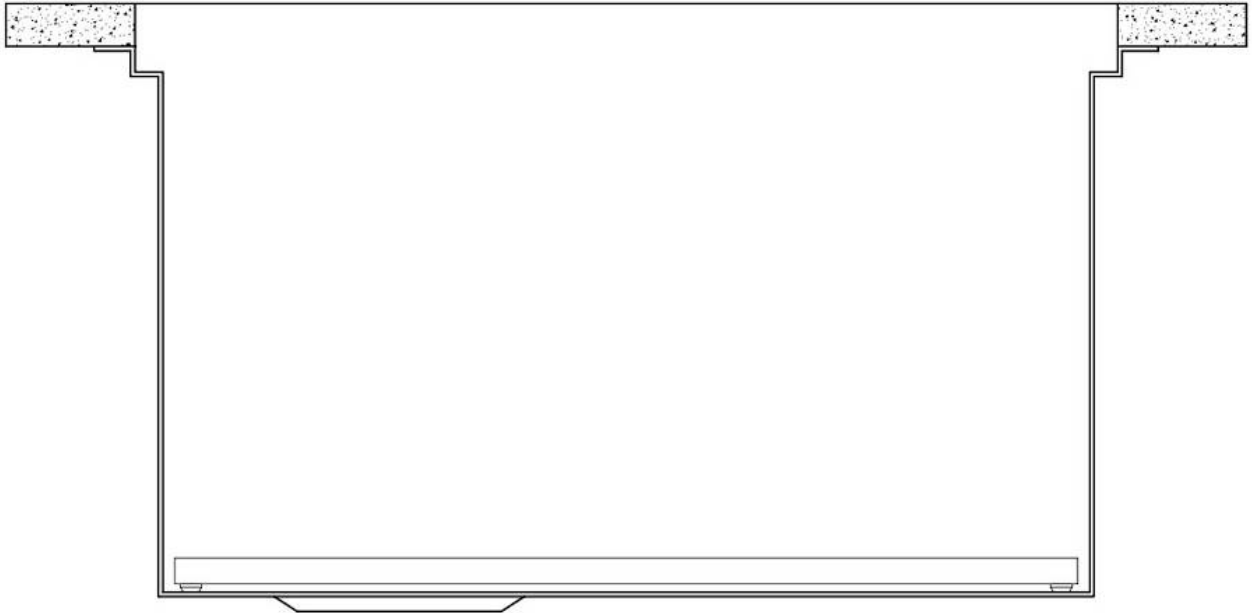

Edge positioning

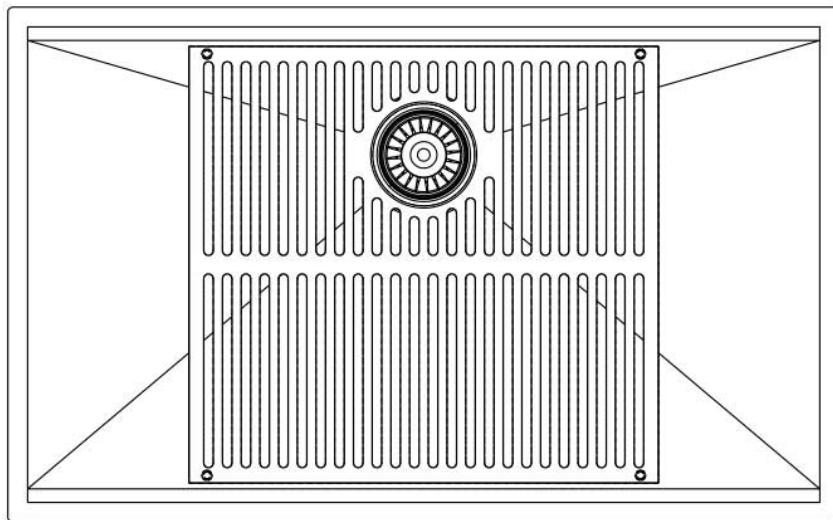
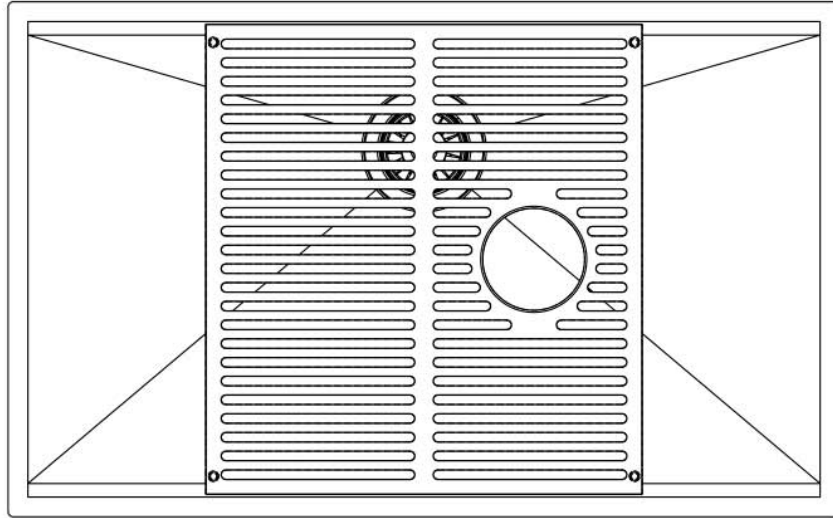

Bottom positioning

OPTIONAL ACCESSORIES



Bottle holder
1773 723



Canova Black grid
8100 605



Grating kit complete with ring support and food collection tray
8159 101
* only in combination with the accessory
8644 102



Knives-holder
8100 030

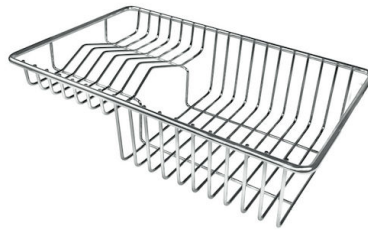

Stainless Steel dishes holder
8100 303
* only in combination with the accessory
8644 102



Stainless steel perforated pan
8151 000
* only in combination with the accessory
8644 102



Twin Chopping Board
8644 102



Twin Chopping Board in HDPE
8644 104



Waste disposer throat
8669 043

RECOMMENDED PAIRINGS



Faucet Capri
8467 005



Faucet Salina
8487 005



Milano Cooktop 4 burners
7637 900

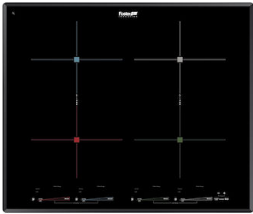

Milano Induction Cooktop 4 Plate
7371 945